

## **MODEL BASED PREDICTIVE CONTROL STRATEGY FOR GRID-CONNECTED WIND ENERGY SYSTEM**

Mariya Paul

Department of Renewable Energy Engineering,  
University of Central Lancashire, Preston,  
United Kingdom.  
*mariyapaul42@gmail.com*

Vineeth Kumar D,

Department of Renewable Energy Engineering,  
University of Central Lancashire, Preston,  
United Kingdom.  
*vineethkumard03@gmail.com*

**Submitted:** Nov, 02, 2021 **Revised:** Jan, 04, 2022 **Accepted:** Jan, 11, 2022

**Abstract:** In recent years, the move to green energy systems for power generation has greatly increased, and Wind Energy Systems (WES) are among the most efficient natural resources. Various control techniques can be employed to improve the amount of power generation and control the system's inverter. This paper implements a new Model Predictive Controller (MPC) for the Wind Energy Conversion System (WECS), which is connected to the grid. The system has wind energy as its input, and its AC source is converted into DC by a rectifier. A boost converter is injected for a constant and boosted DC output voltage from the rectifier, which is then converted to an AC supply by an inverter, controlled by MPC, and then connected to the grid. The proposed system is designed and simulated using the MATLAB tool. The results are verified, and the control technique is very efficient, enhancing system stability for the power generation in WECS.

**Keywords:** Wind energy system, MPC controller, boost converter, wind turbine, pitch angle and grid-connected system.

### **I. INTRODUCTION**

Researchers are focusing their efforts on finding ways to boost the power output of each individual wind turbine as the market for wind power continues to expand. Since of this, wind energy is far more appealing than other forms of renewable energy because it is both inexpensive and kind to the environment [1]. As a wind turbine increases in size and its construction becomes more flexible, the cost of generating one unit of power drops, leading to a lower overall cost. The quantity of kinetic energy that can be extracted from the wind via the use of WECS [2] is then transformed into electrical energy. The WECS is a complex system that draws on the knowledge and experience of engineers specialising in a variety of fields, such as mechanical, aerodynamics, electrical, and civil engineering. The primary elements of a modern wind turbine are the nacelle, the tower, and the rotor. These elements are responsible for housing the transmission mechanism and the generator. [3]

The rotor of the wind turbine consists of two blades that are mechanically attached to an electrical generator. This generator is used to gather the kinetic energy that is created by the wind. Because it is able to transform the slower rotating speeds of the wind turbine into a more astounding speed of rotation on the electrical generator side, the gearbox is a vital component of the mechanical assembly [4]. The rotation of the shaft of the electrical generator, which is driven by the wind turbine, results in the production of electricity, which is then regulated and monitored to ensure that the output satisfies the requirements. These control systems have safeguards built into them to protect the whole system and monitor the outcome [5].

It would seem that wind turbines are the most widely used WECS, and many people anticipate that in the not-too-distant future, these turbines will be able to compete financially with power plants that rely on fossil fuels. However, technological advancement is necessary in order to bring down the cost of producing electricity. Control might prove to be rather useful in this scenario [6] since it has the potential to lower the cost of energy by keeping the turbine's efficiency close to its maximum potential. They have the ability to reduce the amount of structural stress and increase the lifespan of the wind turbine. There is a wide variety of ways available for regulating wind turbines, ranging from the more conventional control methods to the more contemporary control methods [7-8].

The most significant drawback is that the resulting system is very nonlinear, which calls for a nonlinear management strategy to be implemented in order to bring it to its most efficient point of production. Numerous research are now being conducted on the topic of wind power system control. Control strategies such as fuzzy logic systems, adaptive PID controllers, and adaptive neural network control, amongst others, are examples of those that have been proposed as potential solutions. In the last several decades, a number of other predictive control systems, such as model algorithmic control (MAC), generalised predictive control (GPC), and dynamic matrix control (DMC), have been described [9]. In spite of the fact that they are capable of high regulated system performance, only few of them have been implemented in drive applications or electrical devices owing to the enormous amount of computing power that they need [10].

Controlling the WECS and resolving design concerns are accomplished via the use of model predictive control (MPC) in this article. To accomplish the control goals, the recommended approach makes use of a solitary cost function across the board for the various operating modes [11]. This trait makes the controller approach easier to understand when compared to cascaded multi-loop controllers. The MPC family of controllers is a powerful group of controllers that makes use of a system model to forecast future behaviour and choose the most appropriate control action [12-13]. As a consequence of this, the approach takes use of conventional control methods, such as an uncomplicated framework for incorporating operational limits and multiple goals into the MPC cost function. Because of the tremendous advances that have been made in fast digital signal processors [14], MPC is becoming an alternative that is more desirable for applications involving power devices and motorised drives.

The suggested system includes a boost converter, which can bring the voltage from the input up to a higher level. This converter is included into the system so that a greater amount of electricity may be generated by the system and sent to the grid [15]. The boost converter is a kind of DC-DC converter that maintains a steady output voltage while simultaneously increasing the input voltage. After that, it is fed into an inverter, which is controlled by the MPC controller, and the resulting output is an AC supply. Finally, the system is linked to a grid.

## II. PROPOSED SYSTEM

In this paper, WECS is controlled by an MPC controller, and wind energy is given as an input to the system. The power generated depends on the speed of the wind and the pitch angle. The motor is connected to the turbine to generate electricity. The generated AC source from the WES is converted into a DC source by a rectifier, which can be utilized for DC power applications. The DC voltage is increased by a boost converter, which can be used for high power generation. When operating at low-speed conditions, the boost converter increases the voltage more than the input; thus, the load meets the specified requirements without interruptions. The block diagram of the MPC-controlled WECS system is shown in Figure 1.

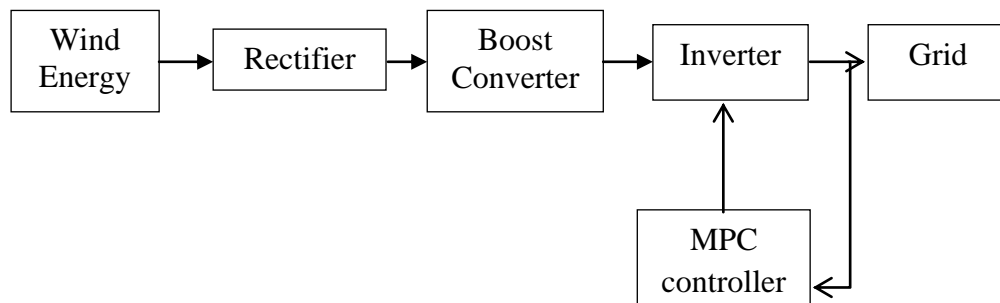
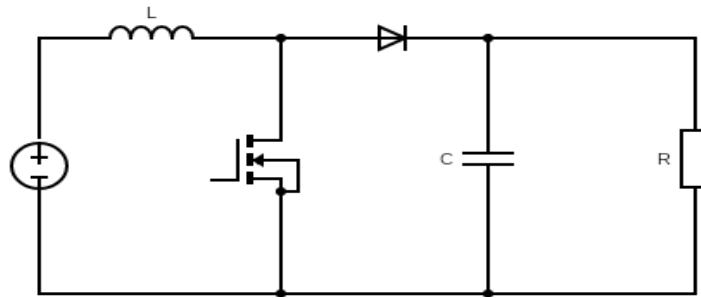

**Fig. 1 Block diagram of the proposed WECS with MPC controller**

The increased DC output voltage of the boost converter is fed to the inverter for converting DC into an AC supply. The inverter gate signals are controlled by the MPC controller, which operates from the feedback signals of the inverter. Then the system is connected to the grid for various purposes.

### A. BOOST CONVERTER

The boost converter consists of two or more switching devices and one or two energy-storing elements. The DC input is connected to an inductor, a switching device like a MOSFET is connected in parallel to the input, and a diode is connected in series to the inductor, which combines a capacitor across a load. The switching operation occurs by varying the duty cycle, and by changing the inductance polarity, the energy is added to the capacitor side. Thus, the output voltage is greater than the input voltage. This converter increases and provides a constant DC output voltage. The circuit diagram of the boost converter is shown in Figure 2. The inductance and the capacitance values should be calculated via equations.



**Fig. 2 Circuit diagram of the boost converter**

### B. MPC CONTROLLER

Because of the advancement of digital microcontrollers, the use of MPC for power converters has expanded. This control approach requires many computations over short sample durations when used to manage power converters and drives.

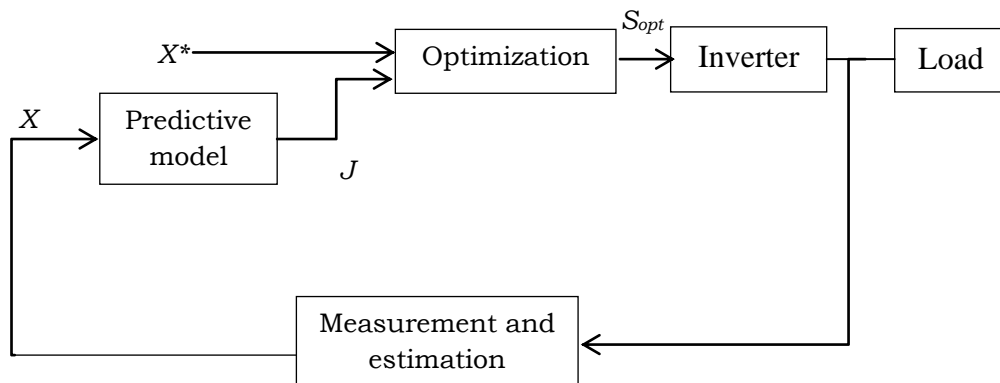
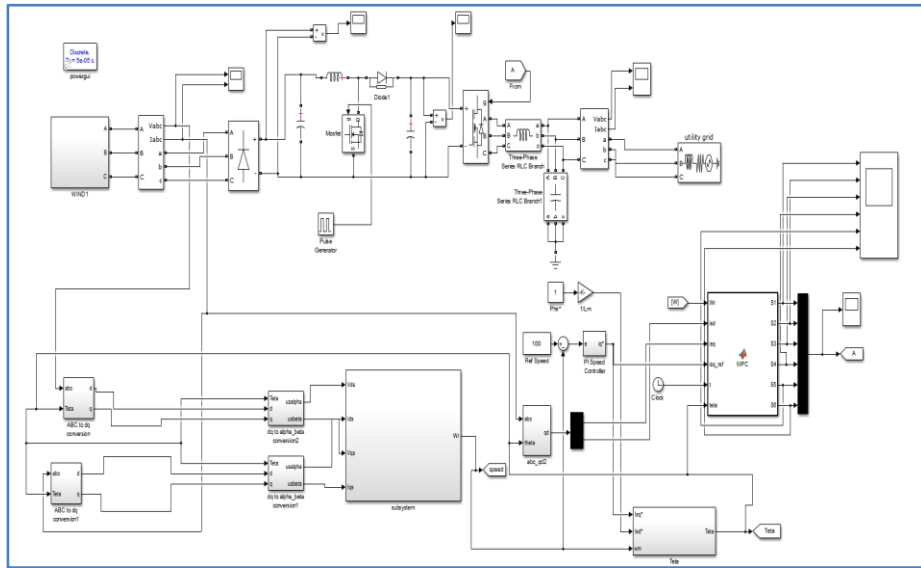

**Fig. 3 Block diagram of FCS-MPC controller**

$J$  represents the various switching states of the converter. To minimize the consequences of the delay produced by the deployment of FCS-MPC on a digital platform, executing the two-time forecast steps is advantageous. Another option for avoiding the impact of the computing delay is to employ a control method that only takes a short amount of time to compute. With this tiny delay and before another sampling moment, the best switching state is given to the converter.

### III. SIMULATION AND RESULTS

A multi-variable system is a wind turbine. As a result, a model-based controller design technique is a useful because it may systematically construct a controller to address the multi-variable control problem. As a result, it's no wonder that the use of MPC in wind energy applications has grown in popularity in recent years. The Simulink model of the system is shown in Figure 4.



**Fig. 4 Simulink model of WECS with MPC controller**

Many have shown that using an MPC approach to design a controller can lead to better mitigation of load and optimal power tracking than a PI approach; this is important because the proportional-integral method is still widely used in the industry. Because actuator restrictions are readily included in the cost function optimization, an MPC method may take a thorough overview.

The WES generates the power and is then converted into a DC source for increasing the voltage using a boost converter in the system. The high DC voltage is again converted into an AC source, and the operations are controlled by an MPC controller for better system performance and higher efficiency. To verify the results, the Simulink model is simulated in MATLAB. The DC output voltage is converted from generated three-phase AC power of the WES using a three-phase rectifier. The results are shown in Figure 5, and the obtained DC output is 40.8 V.

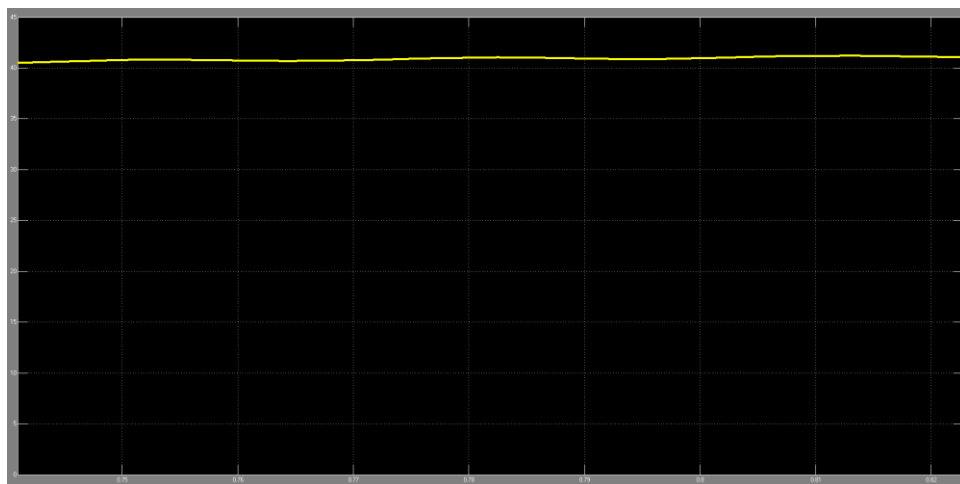

**Fig. 5 DC output voltage of the generator side rectifier**

A boost converter is attached to increase the DC voltage from the rectifier to achieve continuous voltage even at low wind speeds. The boost converter DC output voltage is shown in Figure 6. From the results, the boosted DC voltage is at 93.5 V.

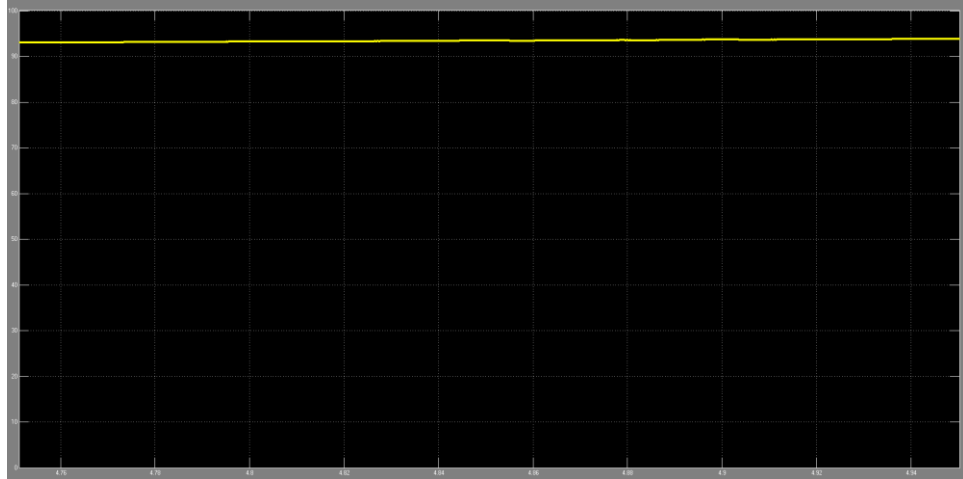

***Fig. 6 DC output voltage from the boost converter***

The generated AC source of the WES is obtained in the grid-side inverter, and the Simulink results show the voltage and current of the generated power shown in Figure 7.

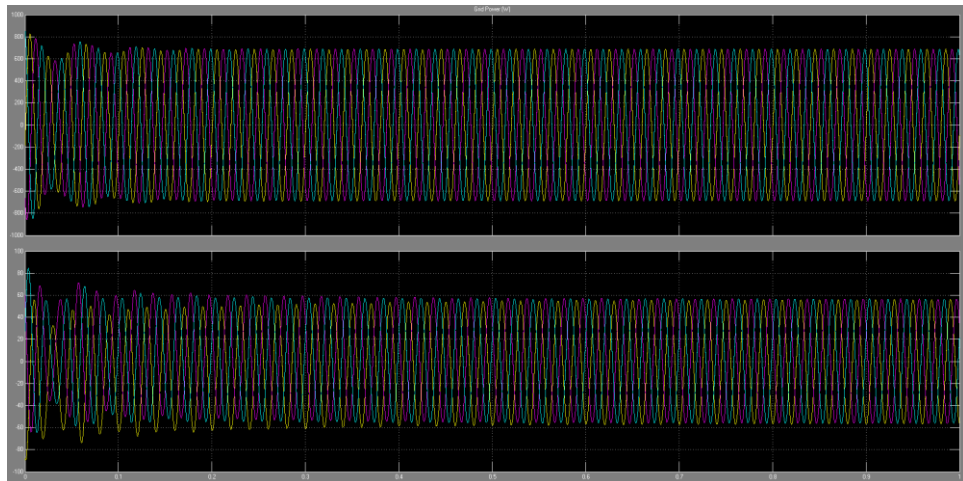

***Fig. 7 Voltage and current source from the generated WES***

#### **IV. CONCLUSION**

To meet the challenges in WECS, various control algorithms can be added to the system for better results. In this paper, WES is controlled by a predictive method called the MPC control technique. It is a method to achieve higher

performance operation in various applications and is also used for controlling electrical drives and machines. The suggested controller does not have any parameters to alter and requires a system model to calculate predictions for the controlled variables. Because the controller generates the gate-drive signals directly, no modulator is necessary. An inner current-control loop enables the output voltage to be regulated without using a cascaded control structure. This allows the voltage control to have a quick dynamic response. A boost converter is implemented to boost the generator side DC output voltage for generating higher voltage under low wind speed conditions. The results are checked and prove that the system is very efficient and enhances the overall performance of the WECS.

**Funding Statement:** The authors received no specific funding for this study.

**Conflicts of Interest:** The authors declare that they have no conflicts of interest to report regarding the present study.

### **REFERENCES**

- [1]. P. Cortés, G. Ortiz, J . I. Yuz, J. Rodríguez, S. Vazquez and L. G. Franquelo, "Model predictive control of an inverter with output \$ LC \$ filter for UPS applications," *IEEE Transactions on industrial electronics*, vol. 56, no. 6, 2009, pp. 875-883.
- [2]. S. Vazquez, J. I. Leon, L. G. Franquelo, J. Rodríguez, H. A. Young, A. Marquez and P. Zanchetta, "Model predictive control: A review of its applications in power electronics," *IEEE industrial electronics magazine*, vol. 8, no. 1, 2014, pp. 16-31.
- [3]. S. Kouro, P. Cortés, R. Vargas, U. Ammann and J. Rodríguez, "Model predictive control—A simple and powerful method to control power converters," *IEEE Transactions on industrial electronics*, vol. 56, no. 6, 2008, pp. 1826-1838.
- [4]. M. Bayat and H. K. Karegar, "Predictive control of wind energy conversion system," *1<sup>st</sup> IEEE International Conference on the Developments in Renewable Energy Technology*, 2009, pp. 1-5.
- [5]. X. Li, H. Zhang, M. B. Shadmand and R. S. Balog, "Model predictive control of a voltage-source inverter with seamless transition between islanded and grid-connected operations," *IEEE Transactions on Industrial Electronics*, vol. 64, no. 10, 2017, pp. 7906-7918.
- [6]. M. Mirzaei, N. K. Poulsen and H. H. Niemann, "Robust model predictive control of a wind turbine," *American Control Conference*, 2012, pp. 4393-4398.
- [7]. A. Gholami, A. Sahab, A. Tavakoli and B. Alizadeh, "DFIG-Based Wind Energy System Robust Optimal Control by Using of Novel LMI-Based Adaptive MPC," *IETE Journal of Research*, 2021, pp. 1-10.
- [8]. A. Jain, G. Schildbach, L. Fagiano and M. Morari, "On the design and tuning of linear model predictive control for wind turbines," *Renewable Energy*, vol. 80, 2015, pp. 664-673.
- [9]. G. Ofualagba and E. U. Ubeku, "Wind energy conversion system-wind turbine modelling," *IEEE Power and Energy Society General Meeting-Conversion and Delivery of Electrical Energy in the 21st Century*, 2008, pp. 1-8.

- [10]. Y. Shan, J. Hu, Z. Li and J. M. Guerrero, "A model predictive control for renewable energy-based AC microgrids without any PID regulators," *IEEE Transactions on Power Electronics*, vol. 33, no. 11, 2018, pp. 9122-9126.
- [11]. W. R. Sultana, S. K. Sahoo, S. Sukchai, S. Yamuna and D. Venkatesh, "A review on state of art development of model predictive control for renewable energy applications," *Renewable and sustainable energy reviews*, vol. 76, 2017, pp. 391-406.
- [12]. M. Aguirre, S. Kouro, J. Rodriguez and H. Abu-Rub, "Model predictive control of interleaved boost converters for synchronous generator wind energy conversion systems," *IEEE International Conference on Industrial Technology*, 2015, pp. 2295-2301.
- [13]. A. Parisio, E. Rikos and L. Glielmo, "A model predictive control approach to microgrid operation optimization," *IEEE Transactions on Control Systems Technology*, vol. 22, no. 5, 2014, pp. 1813-1827.
- [14]. M. Khalid and A. V. Savkin, "A model predictive control approach to the problem of wind power smoothing with controlled battery storage," *Renewable Energy*, vol. 35, no. 7, 2010, pp. 1520-1526.
- [15]. C. Wu, S. Gao, Y. Liu, H. Han and S. Jiang, "Wind Power Smoothing With Energy Storage System: A Stochastic Model Predictive Control Approach," *IEEE Access*, vol. 9, 2021, pp. 37534-37541.